

Massage bathtub

9.5 Temperature adjustment

9.5.1 When the thermostatic heating function is on, press the Function

setting button “” till “°C” on LCD blinks, then press “”

and “” to adjust the temperature. During the adjusting,

LCD displays the setting temperature, then the temperature shall be

increased /decreased 1 °C after press “” and “” once ;

stop adjusting for 5 seconds, LCD shall display the current water temperature.

9.6 If the temperature sensor occurs error, LCD displays “E1” and the controller sounds “di...di...”, in this case the heater cannot be start.

10. Ozone (optional function)

When the pump is working, press “” to turn on or turn off

the ozone. The ozone will be turned off automatically in 10 minutes.

11 Drainage function after power off

Ensure that the main power supply is not cut-off. After turning off the control panel, the drainage valve will be automatically turned on and shut-off after 30 minutes.

User's Guide

IMPORTANT:

Read this manual before proceeding with installation of the bathtub and keep it with the other accompanying documents.

This manual is valid for the installation of tubs both with and without whirlpool.

MODEL: WP-225

SIZE: 1850X1000X720mm



Massage bathtub

Install the diagram

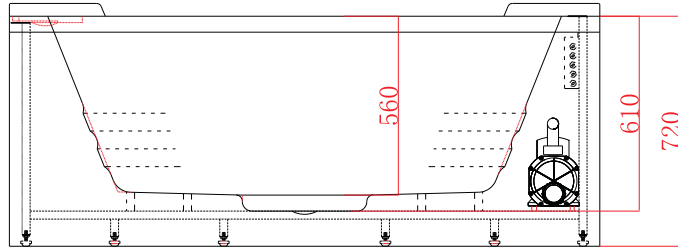

Plane chart

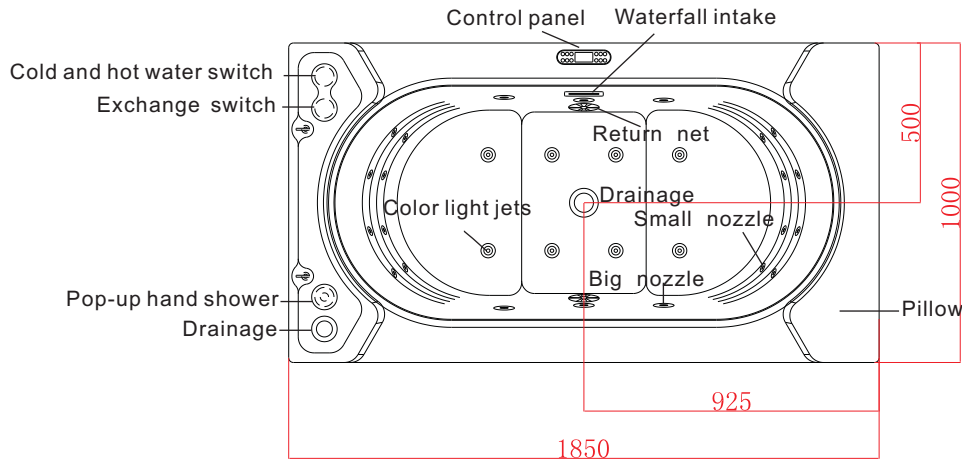

Tap takes over sketch

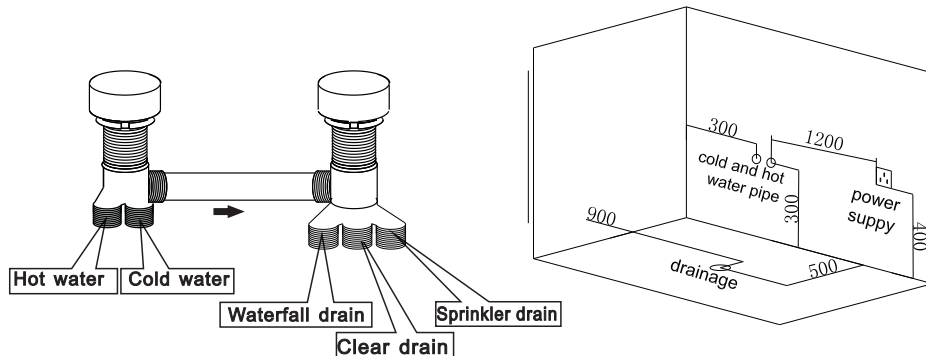



Massage bathtub



8.2 Press “” till the LCD displays “BT--C”, the Bluetooth audio play is turned on; press “” till the “BT--C” disappears, the

Bluetooth audio play is turned off.

8.3 If Bluetooth device is not paired successfully, the LCD blinks “BT - C”; Bluetooth device pairing success, LCD displays “BT--C”.

8.4 When the Bluetooth audio play function is on, press “” and “” to select the songs.

8.5 When the Bluetooth Audio play function is on, press “” for 2 seconds to operate play or pause function.

8.6 When the Bluetooth audio play function is on, press “” till the LCD blinks “VOL”, and then press “” and “” to

increase and decrease the volume. The volume adjusting range shall be 0-20, and 21 in total.

9. Thermostatic heating (optional function)

9.1 This function works only when the water pump surf function is on.

9.2 Press “” to start the thermostatic heating function.

9.2.1 2 seconds later, thermostatic heating function starts or stops according to the temperature

(the temperature that the system defaults is 37°C) :

Controlling rule is as follows:



If the temperature \geq setting temperature + 1°C, stop heating ;

If the temperature \leq setting temperature - 1°C, stop heating.



9.3 Press “” again to stop the function.

9.4 Temperature setting range : 35°C - 45°C

7.3.2 Press “” to decrease the length of one step (the length of one step = 100KHz). Press this button over 2 seconds, the system searches the radio stations of smaller frequencies automatically; the digital phase locked loop will lock the FM station automatically and the liquid crystal shows the frequency of this station; When it reaches to the limit of 87.5MHz, press this button again and the frequency jumps to 108.0MHz.



7.4 When the FM radio is on, press “” till the LCD blinks “VOL” and Numbers, and then press “” to increase the volume and press “” to decrease the volume. The volume adjusting range is 0-20, and 21 in total.

7.5 Station storage/select

7.5.1 Station storage : when FM function is on and select the station frequency to be stored, press “” for 2 seconds to select the location for storage “CH” shall blink, and press “” to choose the location; press the icon “” again, the station frequency shall be stored in the selected storage location.

7.5.2 Station select : When FM function is on, press “” the corresponding stored station can be selected while LCD displays the corresponding storage location number and “CH”, 5 seconds later, LCD displays the volume.

8 Bluetooth Audio Play

8.1 When the system is on and the audio play is off, press “” for 2 seconds to check the Bluetooth device and the pairing code (LCD scrolling displays the Bluetooth device name and pairing code) and then press “” again for 2 seconds to set up the Bluetooth device and the pairing code (LCD scrolling displays the Bluetooth device name and pairing code). During this time, press “” to exit the state (it will be exit automatically of non-press after 12 seconds)

1、Electricity parameter

Rated voltage	Rated power	Rated electric current	Reference circuit voltage
220VAC	3500W	<4A	12V

2、Electric installation

- power supply's establishment should be complied with nation security standard, voltage and frequency also should be accord with product's nameplate. Especially install creep-age protect switch and also check whether can connect with ground.
- The wire collected to the massage bathtub should be fitting permanent., and the wire should be a three-core wire, the sectional acreage of each core cannot less than 12A. when wire pass the wall, it should be use bushing for protection until the AC outlet.
- Ground wire of bathtub should be test whether works with house appliance ground wire.
- The wire end of electricity control box should connect to the control panel, water bottom light, loudspeaker, electrical engineering and the detector protection respectively.

3、Water supply device

- This device's hydraulic pressure is 0.2-0.4Mpa.
- The water supply characteristics on the wall: The cold or hot water supplies inside the bathroom also establish in the shelter of the massage tub, use the hose to connect with the cold or hot joint of the tub. the pipe towards is decide by the customer, the machine do not go with the hose.

4、Installation introduction

- Before install, must consider the place of install massage bathtub whether can support this device's pressure.
- Place the massage bathtub on the install position, adjust level to make the drain system smooth.
- Adjust the leg's screw to make sure all of the screw touch ground completely.
- Install the drain hose, and make some measure to against on the connector.
- Fix cold and hot water-pipe well, then install the showerhead. And then put drain into downcomer, finally connect with power and make sure whether device connected with ground can work.

5、Using Method

- Turn on faucet, adjust water's temperature, add water to the massage bathtub. when the highest water level exceed the highest nozzle about 20-30mm and reach the detector, press the switch button to let the electric machine.
- Revolve the adjust switch, and choose the proper surf pressure.
- After finishing if should turn off pump at first, then open drain button, when water is all out, please make a clean of bathtub to keep in good.

6、Clean and keep in good condition

- usually use soft cloths and general liquid cleanser can wash away dirt, but forbid to use the cleanser with acetone or the ammonia composition; when disinfect, forbid to use the disinfectant contained the formaldehyde.
- the dirty spot of surface can use the toothpaste to wipe with the soft cloth.
- to the low-grade chafe of the surface or burned by cigarette, can soak in water to whet with 2000# levigation sand paper, then polishing.
- If the electroplate piece contain stain, use the soft cloth to wipe lightly, avoid to wiping with coarse cloth.
- often clean up the backwater net cover, prevent it from stop;
- Check whether have break on pipe and waterway aperiodically.

- 6.7 Please check whether there is fall off or breakage on wire, switch,connector plugs so that repair in time.
- 6.8 In order to keep to use in a long term ,please remember, don't use more than 3 hours continually.

7、Fault eliminate

Fault	Cause	Way
Machine or equipment doesn't work	Voltage unstable	Check circuitry
	Power connector didn't connect well or open circuit	Insert again or change power line
	The windpipe connect air switch fall off or break	Connect again or change
	The air switch failure	Change
Big nose of machine	Power's parameter is not same as nameplate	Connect with supplier
	Fixed screw did'n fix or fall off	Fix tightly again
	Support's leg screw did not touch ground	Adjust
water pipe leak out	Aging	Change
	The joint did not fix well	Fix again
	Water pipe or accessory leak	Change

Remark: except this fault, please according to situation to resolve, or find experienced people to repair.

8、special remind

- 8.1 please find qualified people to install bathtub according to introduction.
- 8.2 when you are using it, first of all you have to inject the cold water and then inject the hot water. Don't inject the hot water first.
- 8.3 bathtub's machine must connect on ground, support must use 1.5mm²yellow/green double wire connect with ground and check whether effective.
- 8.4 please do not turn on machine without water, before draining should turn off machine.
- 8.5 children should be looked after in bathtub.
- 8.6 bathtub's temperature can't higher than people average temperature, and the best is 32-37centigrade.
- 8.7 after shower ,please cut off power.
- 8.8 if have these situation ,please do not enter into massage bathtub.
 - 8.8.1 younger than 4 years old's child;
 - 8.8.2 blood circulation unstabled people;
 - 8.8.3 sot;
 - 8.8.4 suffer from flu;
 - 8.8.5 heart disease;
 - 8.8.6 already have sauna;
 - 8.8.7 after meal in half a hour;

Remark: our company has the right to modify the above mention without further notice.

6.Waterfall&whirlpool(optional function)

- 6.1 The water checking device of this controller protects the water pump from burning out.
- 6.2 While the water level achieves the setting value , press “” to start the Waterfall&whirlpool function and the icon blinks on the LCD ; press again, Waterfall&Water pump surf is stopped.
- 6.3 When the water level lowers than the setting value, pump stops working.
- 6.4 When the Waterfall&whirlpool function is on, and the system checks the water level lower than the setting value, Waterfall&whirlpool function stops automatically, at the same time the pump icon blinks. When anytime the system checks the water level achieves the setting value, the icon stops blink and the pump starts to work.



Special alert : When turn on the function of whirlpool massage and

waterfall massage, press () can turn on the electrical water volume adjustment function. Let both massages power keep changing from maximum to minimum then maximum. When the waterfall volume is at is maximum, then the jets are in weakest power, vice versa. Press

() again can stop changing.

7.FM Radio

7.1 The FM frequency scope is 87.5MHz—108.0MHz.

7.2When the system is on, press the button “” to turn on the FM Radio Function, at the same time, the LCD displays the current frequency and “FM” “MHZ”; press the icon “” again ,FM function stops while the current frequency and “FM” disappears.

7.3 When the FM function is on, press “” till the LCD blinks “FM” and “MHZ”, the system enter into the state of adjusting the frequency.

7.3.1press “”to increase the length of one step (the length of one step =100KHz): Press this button over 2 seconds, the system searches the radio stations of larger frequencies automatically; the digital phase locked loop will lock the FM station automatically and the LCD shows the present frequency, when it reaches to the limit of 108.0MHz, press this button again and the frequency jumps to 87.5 Mhz.

Schematic Diagram of control panel

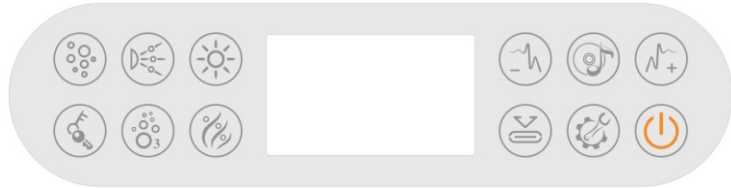

- | | |
|-------------|-----------------------------|
| 1) Blower | 7) Function setting |
| 2) Pump | 8) Channel storage/select |
| 3) Lamp | 9) Volume /frequency minus |
| 4) Lock | 10) Volume /frequency plus |
| 5) Ozone | 11) MP3、FM、Bluetooth、TV |
| 6) Heating | 12) Power on/off |

3.Operation of Control Panel

1. When any function button works, there is a sound of “di...”

2. Press “” for 2 seconds to start the controller ,at the same time, the lamp is turned on ; press the icon again to stop the controller and all the loads is turned off.

3. If no operation with the control panel for 5 minutes, all the keys will be locked except “LOCK”, LCD displays “LOCK”.

4.Press the power switch icon, lamp is turned on, LCD displays “”; then press“”, lamp is turned off ; press “” another time, lamp is turned on.

5. Blower(optional function)

When the system is on, press the button“” to start blower function, while the LCD blinks the icon“”; press this button again, blower is off and the LCD shows the icon“” statically.

Bathtub User’s Guide

WARNINGS

1. Please follow the instruction contained in the attached installation manual to ensure that the product is installed properly. the manufacturer will not be held liable for damages or injuries caused by improper installation.
2. Follow the instructions contained in this manual when using the product.
3. Before using the bathtub, check the local voltage that if reach to the rated voltage(pre-installation card).

CONTENTS

- Safety Precautions
- Brief Introduction
- Operation of Control Panel

1. Safety Precautions

【Warning】

1. In order to prevent fire or electric shock accident, do not expose the controller to the rain or humid environment. There are dangerous high-tension fittings inside the controller, therefore do not open the cover. Entrust the repairing work only to the qualified professional repairing personnel when repairing is required.
2. Without the clear approval from the controller manufacturer or its authorized units, any change or alternation to this controller might bring various inconveniences to the users when in use.

【Helpful suggestion】

1. In order to prolong the service life of this controller, the time interval for continuously turning on and off the machine must be over 30 seconds.
2. Please switch off the power after use.
3. The power supply used must be consistent with the voltage specified value indicated on this controller; otherwise it will not work, or even burn out the controller.
4. When installing this controller, carefully check if the load parameters are consistent with the parameters required by this controller, otherwise it will not work, or even burn out the controller.
5. If it is halted accidentally, please close and restart.

2. Brief Introduction

1. General Description of Functions

Functions		Model	PB304
1	Touching Technology		✓
2	Lock		✓
3	Waterfall&whirlpool		✓
4	Blower		*
5	Bottom Light		✓
6	Thermostatic Heating		✓
7	FM Digital Turning Radio		✓
8	Bluetooth Audio Play		✓
9	Level Detection		✓
10	Ozone		*
11	Cleaning		✓

Note: “*” stands for the optional function.

2.1 Controller System Including :

- 1) Control panel (1) ;
- 2) Control box (1) .

2.2.Characteristics of the Controller

- 1) Rated voltage : AC220V ~AC240V
- 2) Working voltage range : AC198V ~ AC248V
- 3) Rated power : 50HZ/60HZ
- 4) Power consumption : <10W (all loads OFF)
- 5) Applied ambient temperature : +5°C~ +40°C

2.3 Devices controlled by the controlling system

- 1) Water pump surf : AC220V/3HP
 - 2) Thermostatic heating : AC220V/2000W
 - 3) **Blower** : AC220V/1HP
 - 4) Bottom lamp : DC12V/5W
 - 5) alternate output : AC12V/6W
- Loudspeaker : 8Ω/15W

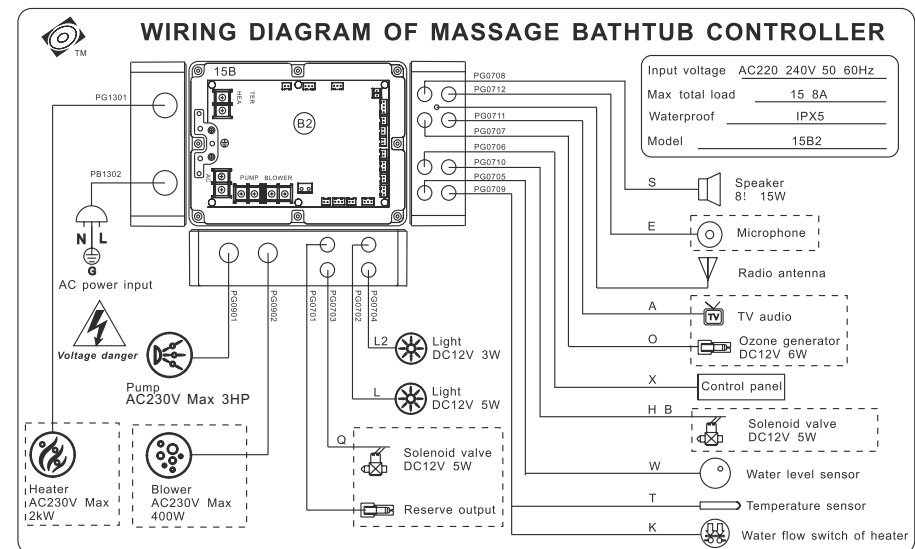

5. The LCD shows the following information

